

Trends in Standardization of Optical Access Networks in ITU-T

Frank EFFENBERGER^{†a)}, Nonmember and Jun-ichi KANI^{††}, Member

SUMMARY This paper reviews the standardization work that has been done in question 2 of ITU-T study group 15, which is the lead group on optical access transport technology. The major topics covered are the progress in the G-PON series and the new point-to-point fiber access recommendation. Finally, a brief view of the future plan of XG-PON is presented.

key words: ITU-T, optical, fiber, PON, access

1. Introduction

The ITU’s telecommunication standardization sector is responsible for developing high quality industry-driven recommendations that describe all aspects of the world’s networks. ITU-T’s study group 15 (SG-15) is responsible for optical transport technology, and question 2 (Q2) of SG-15 is where optical access networks are studied. In the past 4 year study period from 2005 to 2008, a great deal of work has been done to further develop the various standards that describe practical fiber-based access networks, so that it has supported Fiber To The Home (FTTH) to take off to the wide deployment [1].

It should be mentioned that the IEEE 802.3 working group has also produced a series of optical access standards, including Gigabit and 10 Gigabit Ethernet PON, and 100 Megabit and Gigabit Point to Point systems. While this paper will not describe these standards, it recognizes their strong impact. Indeed, one of the future ITU efforts will be to specify how these standard families relate to each other.

Before beginning to consider the technical details, some basic architecture and terminology concepts should be laid out. Figure 1 shows a generic optical access network, with a listing of the common acronyms. The equipment at the central office is referred to as the OLT, while the equipment at or near the customer premise is called the ONU. The OLT and ONU are connected by a single fiber ODN, and different wavelengths are used to diplex the downstream and upstream transmissions. In addition, a video overlay wavelength can be added.

Considering the passive optical network (PON) topic, Q2 has a long history of system development, starting from ATM-PON (A-PON) in the 1997 to 2000 period, which then

evolved to become the broadband PON (B-PON) in the 2001 to 2004 period [2]. Both of these were standardized in the G.983 series of standards. In the 2001 to 2004 study period, the more modern gigabit PON (G-PON) was initially standardized with a series of four Recommendations [3]–[6]. But just as A-PON was continuously improved, G-PON has undergone extensive enhancement including addition of two Recommendations to the G-PON series [7], [8]. The highlights of this improvement process are outlined in Sect. 2.

The alternative to PON is point to point access, and Q2 has also done its part to normalize such systems. In the 2001–2004 study period, a 100 Gb/s single fiber point to point recommendation was published [9]. Currently, a 1 Gb/s version of this system is being developed. The major themes of this development are outlined in Sect. 3.

Looking forward to the current study period of 2009 to 2012, Q2/15 plans to develop even faster and more capable access systems. The fourth section gives a brief preview of the standardization plan for the next generation PON sys-

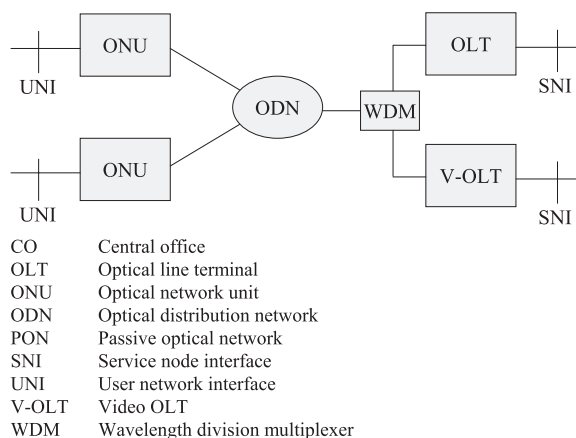

Fig. 1 A generic optical access system and terminology.

Table 1 ITU-T recommendations for optical access systems mentioned in this paper.

Number	Intended system
G.983 series	Broadband PON (B-PON)
G.984 series	Gigabit-capable PON (G-PON)
G.985	100Mbit/s point-to-point
G.986	1Gbit/s point-to-point: under development
G.xgpon series	10Gigabit-capable PON (XG-PON): under development

Manuscript received June 1, 2009.
 Manuscript revised August 20, 2009.

[†]The author is with Huawei Technologies USA, 1700 Alma Dr. Plano TX 75075, USA.

^{††}The author is with NTT Access Service Systems Laboratories, Yokosuka-shi, 239-0847 Japan.

a) E-mail: feffenberger@huawei.com
 DOI: 10.1587/transcom.E93.B.255

tem.

Table 1 summarizes the ITU-T Recommendations for optical access systems mentioned in this paper: all of the Recommendations, except for those under development, can be freely downloaded at [10].

2. Recent Progress of G-PON

The G-PON series of recommendations (G.984.x) is the basis for many deployments of fiber access networks around the world. As its application grows more widespread, more and more features and improvements are included in the standard. This section reviews the major G-PON projects that have been completed in the past few years.

2.1 Wavelength Allocation

When G-PON was first developed, its wavelength plan was kept simple, with as few constraints as possible on the implementation. The intention of doing this was to promote cost-effective components and systems that met the basic network requirements. While this was correct for the initial stages of deployment, it became apparent that some revision of the wavelength allocation could yield additional capabilities such as upgradability and optical amplification. Therefore, Q2/15 began a deliberation to improve the wavelength allocation for G-PON, which has become the ITU-T G.984.5 recommendation. This recommendation has three major technical areas, which are outlined below.

ONU blocking filter

The first requirement for enabling future upgradability of PONs using additional wavelengths is that the equipment on either side of the network must be blind to these wavelengths. Of particular concern is the ONU, as there are many more ONUs than OLTs, and the ONUs are in the field and not so easy to access in all circumstances. Therefore, there is a great benefit to define the ONUs to have a built-in filter that blocks all wavelengths other than the ones allocated for downstream G-PON transmission. In the case of video overlay equipment, a similar blocking filter for the video receiver can also be defined. Figure 2(a) illustrates the block diagram of a G-PON ONU employing the blocking filter.

The key issue when defining these filters is their precision and isolation. If the specification requires an isolation that is not practically attainable, or a guard-band that is too narrow to implement reliably, then the filter will be too expensive. The G-PON ONU is very cost sensitive, so the blocking filter must be affordable, so that network operators can justify paying for its cost today knowing that it will pay back its value several years into the future. So, the definition of the filter was carefully tailored to provide the maximum protection for the G-PON receiver while remaining cost efficient. The characteristic of the filter is described in Fig. 2(b). It should be noted that the filter is defined in the X/S formalism, which allows for measurement in integrated components and systems. The standard interferer was defined to be an STM-16 signal format, which should be the

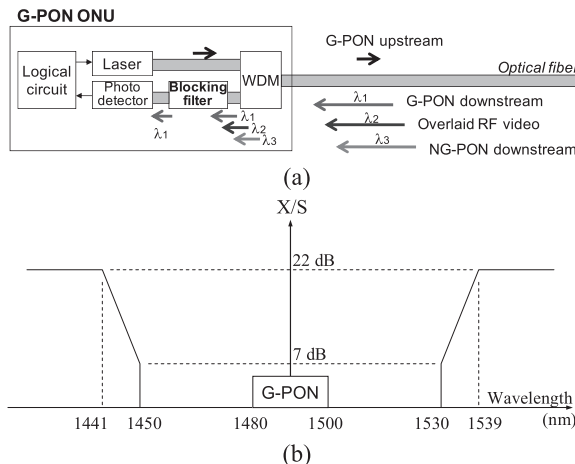

Fig. 2 (a) G-PON ONU employing the blocking filter, and (b) characteristic of the blocking filter as defined in G.984.5.

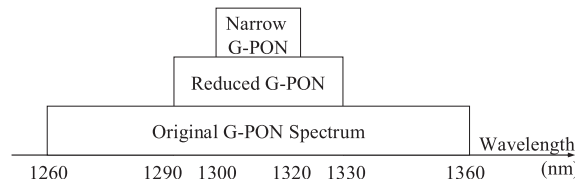

Fig. 3 The ONU spectrum plan options as defined in G.984.5.

worst case because it matches the G-PON downstream signal in line rate and coding.

The upstream spectrum options

The originally defined spectrum plan for G-PON set the entire “O-band” for use in the upstream direction, from 1260 nm to 1360 nm. This very wide spectrum allowed the possible use of Fabry-Perot lasers, however, all practical G-PON implementations have used distributed feedback (DFB) lasers, and these operate in a significantly reduced spectrum. The motivations to specify a more conservative spectrum plan are to reserve wavelengths for future use, and also to limit the required bandwidth for optical amplifiers.

As with the blocking filters, the key tradeoff here is to reduce the spectrum as much as possible without unduly burdening the cost of the G-PON equipment. In the end, there were two possible spectrum widths defined. Figure 3 shows the upstream bands specified (note that the downstream wavelengths not in this spectral region). The “reduced” spectrum was 40 nm wide, while the “narrow” spectrum was 20 nm wide, both centered on 1310 nm. The reduced spectrum was chosen because of the practical matter that nearly all G-PON ONUs would comply with this spectrum allocation. In this sense, the “reduced” spectrum was the de-facto allocation of practical equipment. The narrow spectrum was chosen because 20 nm is about as narrow as one can define a DFB laser spectrum and still allow uncooled operation over an industrial temperature range (−40C to +85C).

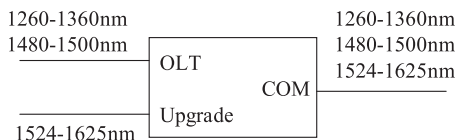

Fig. 4 The WDM1 filter defined in G.984.5.

The WDM1 filter

The counterpart of the ONU blocking filter is a multiplexing filter at the OLT side that combines the G-PON wavelengths with the future PON system wavelengths, and optionally the video enhancement band wavelengths. The exact design of this filter was speculative, since the future PON system had not been defined. Still, it was assumed that for a future system that operates in the 1550 nm wavelength region, various filter characteristics could be hypothesized. Figure 4 shows a diagram of the filter. This was captured in an informative appendix, to reflect this non-confirmed status.

2.2 Optical Line Supervision (OLS)

As G-PON networks move into large scale, more attention has turned to their ongoing operation. As the access network endures its multi-decade service life, some degradation of the fiber and the optical components is bound to happen over time, and various faults will occur. The current testing methods for fiber systems are largely manual, and require expensive equipment. This was sufficient for the optical transport network, but for the access network it becomes impractical due to the vast numbers of lines involved. As the telephony network has automatic metallic loop testing capabilities, it would be very useful if PONs could have similar built-in optical testing functions. In this way, the network could diagnose troubles, and potentially even predict problems before they impair transmission. Providing these functions was the objective of work in Q2/15, culminating in revisions to the G.984 series.

Potential technology solutions

At the start, a variety of monitoring solutions were considered, ranging from the very advanced optical time domain reflectometry (OTDR) schemes to the very simple fault correlation diagnostic methods [11]. The OTDR schemes promise to provide very detailed information on exactly where an optical fault has occurred, and what kind of fault it is. However, it also appeared to carry a significant cost that appeared unsupported in the market. Also, the very high splitting loss makes it very difficult to perform an OTDR measurement through a splitter. This would mean that the OTDR equipment would need to be located at each ONU. For these reasons, the OTDR approach was not selected.

The fault correlation techniques are the exact opposite, in that they carry no extra cost, and rely only on the intelligent processing of existing alarms and performance monitoring information. An example of this kind of technique is where the OLT notes that a group of ONUs all simultaneously drops off the network. The OLT can make the infer-

ence that a fiber that is common to these ONUs must have been cut, and report this to the operations support system. While this approach has merit, it also does not require standardization, because it is an OLT implementation issue. So, this was not the focus of the optical line supervision work.

The middle approach was to consider what physical layer measurements could be obtained at a low cost. It was determined that the optical transceiver parameters such as power, temperature, and bias current were typically available from many implementations, and were needed to support cost-effective manufacturing. For this reason, this approach was selected as the centerpiece of OLS research in Q2/15.

Transceiver parameter monitoring

The selection of parameters took as its main guide the capabilities of many small form-factor pluggable optical modules. In such modules, various practical measurements are made available via a control interface to the host system. From this menu of available measurements, the set of seven parameters was selected.

One of the key considerations in defining these specifications was settling on the requirements for accuracy and repeatability. In order to be usable for OLS, a relatively high quality measurement is needed; however, it is difficult to guarantee this in the very inexpensive PON optics. For this reason, the question of measurement quality was broken into two parts. The accuracy of the measurement (the difference between the measured value and the true value) is given a loose specification. The repeatability of the measurement (the difference between any two measurements made at identical conditions) is given a tight specification. This provides the best possible precision at an affordable cost.

OLS in the standard

The OLS capability is captured over three standards in the G.984 series. In the G.984.2 Amendment 2, the basic capability of the transceiver parameter measurements are enumerated, including a table of range, resolution, accuracy, repeatability, and response time for each parameter (see Table 2). In G.984.3, a small addition of the reporting of the ONU response time was added in the revision of G.984.3. In G.984.4, additions of attributes to capture the measured optical parameters were added, as were new alarms to signal out-of-range conditions, and the new method by which an ONU could return an autonomous test result to the OLT. All in all, these additions to the standard represent a significant improvement in equipment specification.

2.3 Reach Extension

Fiber access systems present the opportunity to explore longer reach. Indeed, the basic G-PON system provides for a passive physical reach of 20 km, which is quite a bit more than comparable copper-based access systems. This capability can cover the large majority of the customers in the existing network. For example, in the USA over 90% of ex-

Table 2 The OLS specifications in G.984.2 Am. 2.

Parameter	Typical Range	Resolution	Accuracy	Repeatability
Temperature	-45 to +90 C	0.25 C	± 3 C	± 1 C
Voltage	0 to 6.55 V	0.5 %	± 3 %	± 1 %
Bias Current	0 to 131 mA	1 %	± 10 %	± 5 %
ONT Tx power	-10 to +8 dBm	0.1 dB	± 3 dB	± 0.5 dB
ONT Rx power	-34 to -8 dBm	0.1 dB	± 3 dB	± 0.5 dB
OLT Tx power	-10 to +9 dBm	0.1 dB	± 2 dB	± 0.5 dB
OLT Rx power	-34 to -8 dBm	0.1 dB	± 2 dB	± 0.5 dB

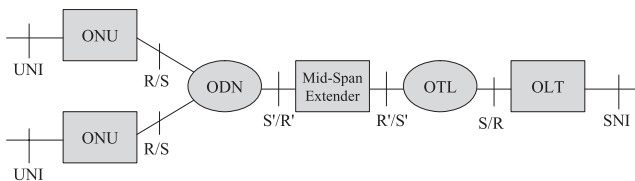
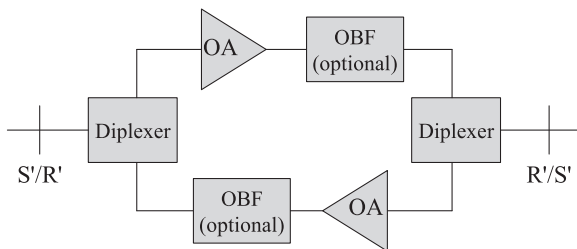
**Fig. 5** A mid-span reach extended PON.**Fig. 6** Optical amplifier based reach extender defined in G.984.6.

isting customers are within 20 km of the central office. However, there are locations that are beyond the basic reach. Additionally, there is interest in reducing the number of central offices by reworking the lower tier of inter-office facilities to become part of the access. In either case, a greater PON physical layer capability is needed, and PON reach extender systems can be a solution. ITU-T Q2/15 considered the design and specification of reach extenders, and this produced the G.984.6 recommendation. The most basic schematic of an amplifier based reach extender is shown in Fig. 5. The reach extender connects to a typical optical distribution network (ODN) via its S'/R' interface, and to the optical trunk line (OTL) via its R'/S' interface. The OTL completes the connection to the OLT. There are two techniques described in G.984.6: optical amplifier based and opto-electronic optical (OEO) based. The following sections describe the key aspects of these two types.

Optical amplifier based reach extenders

The basic schematic of an amplifier based reach extender is shown in Fig. 6. This equipment provides optical signal gain, and is a signal repeater that provides no reshaping or retiming in general. In this sense, it is a very simple device. However, the wavelength plan requires the downstream amplifier to handle wavelengths of 1480 to 1500 nm, and the upstream amplifier to handle one of the 1310 nm wavelength bands (described in Sect. 2.1). The width of these bands is something of a challenge to provide a uniform

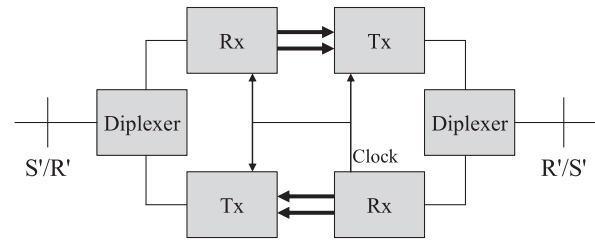
**Fig. 7** OEO based reach extender defined in G.984.6.

gain across. More importantly, the amplified spontaneous emission (ASE) of the amplifier is proportional to the bandwidth, and with practical amplifiers the ASE power can rival that of the signal [12]. This large ASE reduces the extinction ratio of the signal, which can have some impact on the operation of some OLT receivers. It also adds a noise source (signal-spontaneous beat noise) to the system that limits the effective sensitivity. Another complication is that the upstream PON signal has a dynamic range of 20 dB, and the strong bursts can drive the amplifier into saturation. Both the noise limitations on the low end and the distortion limits on the high end tend to make the operating power ranges somewhat complex in practice.

OEO based reach extenders

The schematic of a simple OEO reach extender is shown in Fig. 7. This equipment provides a bit more functionality than an amplifier, in that it provides reshaping and retiming (a full 3-R function). This has the favorable side effect that the optical parameters of the S'/R' interface are essentially those of a standard OLT's S/R interface, and the R'/S' interface are equivalent to those of a standard ONU's R/S interface. The price one pays for this is a lack of optical transparency.

In addition, to maintain the required clock jitter at the OLT, the clock recovered from the downstream must be used to retime the upstream. This requires the burst-mode reception process to be done at the reach extender. A complication is that the extender does not have access to a reset signal that is required by many burst mode receiver circuits in order to reset some parameters such as the gain before the start of receiving each burst. This requires the reach extender to either generate its own reset signal (e.g., by looking for the end of the burst), or to implement a reset-less burst mode receiver. In either case, an OEO extender will consume some of the burst overhead for its own receiver, on top of the overhead needed for the OLT's receiver. The ONU's must increase its preamble length to compensate.

Management of reach extenders

Given that a reach extender is an active network element, it requires management accessibility, including support of alarms, performance management, and provisioning. A separate management wavelength was considered, but it was determined to be too costly an approach. Rather, it was decided to utilize an embedded ONU function to provide the basic connectivity between the OLT and reach exten-

der equipment. The ONT management and control interface (OMCI) protocol is used to provide the management functions for the reach extender. This choice allows the PON and all of its components to be in a single management domain, controlled and administered by the OLT equipment.

2.4 G-PON Revision Project

Ever since the G-PON series was completed, additional work to refine and improve it has taken place. ITU-T Q2/15 has the responsibility to support this maintenance work, and the outcome has been a steady stream of amendments. From time to time, a sufficient body of new work accumulates, and a revision process commences. However, a revision is more than just an editorial exercise in document merging. Rather, it is an opportunity to critically review the entire body of the standard, to address areas that need clarification or improvement, to deprecate features that have fallen into disuse, and incorporate new material of current usage. Three of the four main G-PON documents have undergone revision recently.

G.984.1 revision

The initial version of the G-PON service requirements recommendation has remained largely intact, as the full service access network is still the goal of G-PON. There have been a few tailoring changes to the list of services that are relevant, with some obsolete services such as ATM-50 being removed. More significantly, updated requirements on access survivability have been added. The novel concepts raised here are the possibility of other access modes such as wireless or copper being used as a back-up to the fiber access system. In addition, the possibility of dual-homing was raised, where the back-up access was derived from a completely different service node. Both of these new techniques are not likely to provide true fast protection, but rather rapid service restoral and network resilience.

Another major addition to G.984.1 was the illustration of the major equipment structures and service creation protocol stacks. Until this revision, the standard was silent on these practical concerns. While appropriate in the early stages of system development, this topic is much too important to leave entirely unexplained. The revision of G.984.1 contains a sizable appendix that enumerates the common equipment layouts for OLTs and the many types of ONUs. It also illustrates the many different protocol stacks that are present in the OLT and ONUs to derive all the classes of services used in modern equipment.

G.984.3 revision

The transmission convergence layer of G-PON has undergone an evolution that has simplified its basic structure. When it was first devised, the availability of some service adaptations over Ethernet was not clear, and so ATM support was incorporated into the TC-layer. As G-PON deployments have begun in earnest, these concerns about Ethernet have been reduced due to the widespread support of the IETF PWE3 protocols. For this reason, ATM support has been deprecated from the G-PON TC layer. Deprecation

indicates that a feature is not to be used, but the feature's protocol fields and other aspects are left in place to maintain backward compatibility. In this way, the protocol can evolve, but existing implementations continue to operate.

Another major improvement in G.984.3 is the clarification of the dynamic bandwidth allocation system. The initial version of G.984.3 had a treatment of DBA that centered on the ATM-style of QoS controls; that is, it was individual connection oriented. Contemporaneously with the introduction of G-PON, the IETF Diffserv-style of QoS has gained predominance. The DBA descriptions in G.984.3 have been modified to more accurately and simply model the diffserv model, using a multiple transmission container model. In addition, the requirements on DBA performance have been expressed in terms that are objectively measurable.

G.984.4 revision

The OMCI is the largest recommendation in the G-PON series. What is unique about the OMCI is that it describes the entire body of ONT management capabilities in a single document. This is a different approach from most management techniques (e.g., SNMP), where the base document only describes the information format and channel, and then the actual MIBs are defined in a myriad of auxiliary documents. Essentially, the G.984.4 document performs the compilation work for the reader, and puts the entire scope of ONT management into a single self-coherent document.

The initial version of G.984.4 was based on G.983.2 (the OMCI for B-PON). As such, many of the sections in G.984.4 reference G.983.2. This was useful when much of the active MIB development work was occurring in the B-PON series. When the focus of the industry moved from B-PON to G-PON, so did the focus on the OMCI. So, the first order of business in the revision of G.984.4 was to resolve the references such that the actual material was copied to G.984.4. With the completion of this work, G.984.4 was a free-standing document, and G.983.2 was essentially "frozen" with no further work being done.

Now that G.984.4 has been revised, it continues to be augmented with additional management features to describe new functions. There is also a significant effort in the industry to promote interoperability of G.984.4 implementations. This has resulted in a G.984.4 implementer's guide, which provides many illustrations of exact message sequences and other details that have proved to be impediments to interoperability.

3. Progress of Point-to-Point Optical Access

This section describes the work that has been undertaken in point to point optical access. There are two major efforts. The first is to define a Gigabit rate point to point access system. The second is to define a silent start function for all point to point systems.

3.1 Gigabit Point-to-Point Optical Access System

The point-to-point optical access systems are another solu-

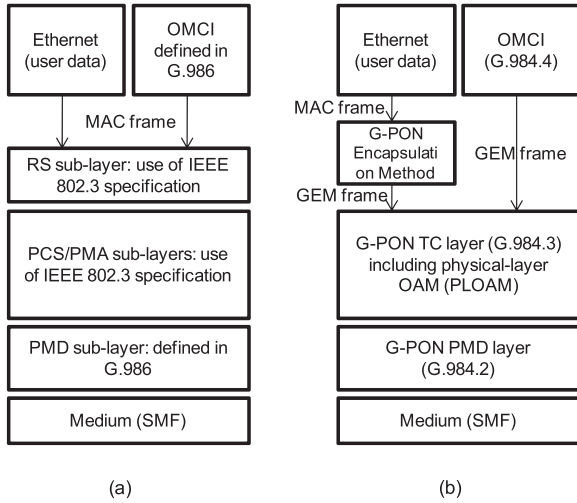

Fig. 8 Protocol stacks of (a) 1-Gbps point-to-point Ethernet-based optical access system and (b) G-PON system.

tion to complement PON systems to cover various application areas in FTTH. For example, point-to-point systems can be applied to apartments where ONU is placed in the basement and VDSL is used inside the building. Another example is to provide a guaranteed broad bandwidth, e.g. 100 Mbps or 1 Gbps, to large-scale business customers. For these applications, the 100-Mbps point-to-point Ethernet-based optical access system was published as ITU-T Recommendation G.985 in 2003.

To accommodate with requirement of a broader bandwidth, the 1-Gbps point-to-point Ethernet-based optical access system is under standardization in ITU-T; it is anticipated to be consented as G.986 in 2009. It uses the Gigabit Ethernet interfaces specified in IEEE 802.3 as the base, and extends the specifications to accommodate the following requirements from the network operators' point of view.

- Three loss-budget classes — Class S (max. 15 dB), Class A (max. 20 dB) and Class B (max. 25 dB)
- Extended Operation, Administration and Maintenance (OAM) functions

Figure 7 shows the protocol stack with compared to that of G-PON. The 1-Gbps point-to-point optical access system uses the RS (Reconciliation), PCS (Physical Coding Sub-layer) and PMA (Physical Medium Attachment) sub-layers specified in IEEE 802.3. Extension of the OAM functions is done by OMCI messages, that are defined for G.986 using the same frame structure as OMCI in G-PON defined in G.984.4. The OMCI messages are carried over Ethernet frames, i.e. MAC frames, in G.986 while they are over GEM frames in G-PON as you can see in Fig. 8. Table 3 shows the OAM functions and applicable implementations anticipated to be specified in G.986. As explained in the table, each function is implemented by an OAM message specified in IEEE 802.3 and/or an OMCI message specified in G.986.

Table 3 OAM functions and applicable implementations in the 1-Gbps point-to-point Ethernet-based optical access system.

OAM functions		Applicable specifications
ONT status notification	ANI status	IEEE 802.3 Clause 57
	ONT vendor code and ONT model number	ITU-T G.986 OMCI
	UNI status	ITU-T G.986 OMCI
ONT remote setting	UNI status	ITU-T G.986 OMCI
Fault management	Power supply	IEEE 802.3 Clause 57 and/or ITU-T G.986 OMCI
	ONT failure	IEEE 802.3 Clause 57 and/or ITU-T G.986 OMCI
	Received signal	IEEE 802.3 Clause 57
	UNI status	ITU-T G.986 OMCI
Loop-back test	UNI loop-back status	ITU-T G.986 OMCI

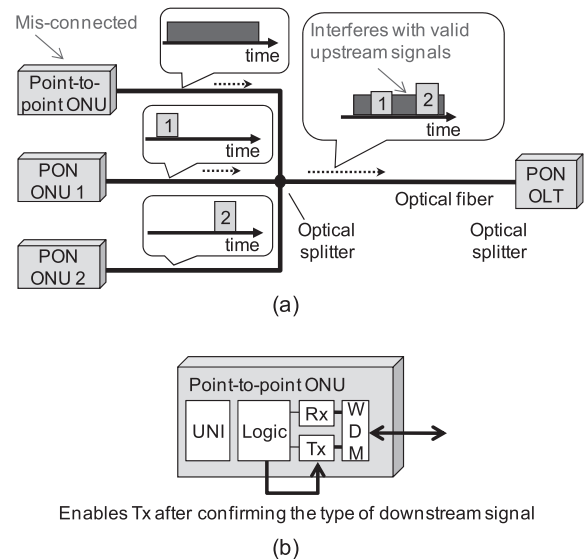

Fig. 9 (a) Misconnection of point-to-point ONU to a PON branch, and (b) the silent-start function in the point-to-point ONU.

3.2 Silent-Start Function

Another important requirement from the viewpoint of network operators is that any mis-connections of a point-to-point ONU to a PON branch should not induce a PON outage. For this purpose, both G.985 and G.986 recommend to employ a 'silent-start' function as described below.

Figure 9(a) illustrates a case of mis-connecting a point-to-point ONU to a PON branch [13]. While each PON ONU sends his/her upstream signals only in the assigned timeslot, a point-to-point ONU basically continues to send his/her upstream signals according to IEEE standard 802.3: it specifies to send idle patterns even when there is no data to send. Therefore, the upstream signals from the point-to-

point ONU can interfere with valid upstream signals sent from PON ONUs, and may induce a service outage for all the PON users in the worst case as shown in Fig. 9(a).

The silent-start function is illustrated in Fig. 9(b). It is a function to disable the optical transmitter in the point-to-point ONU initially, and to enable the transmitter to enter a handshaking process with the point-to-point OLT on the other side only after confirming that the frame structure and/or the line coding of the received downstream signal are matched with those the ONT complies with. By employing this function, network operators can avoid disturbing other access systems in case of misconnection such as described above.

4. Next Standards

This section reviews the major new standards that Q2/15 will be working on in the 2009–2012 study period.

4.1 Next-Generation 10G-Capable PON

The inexorable increase in bandwidth demand will eventually cause even G-PON to exhaust. By all accounts, this will not occur imminently, but in perhaps 3 to 5 years. It is the right time, therefore, to begin the standardization of the next generation of PON system, so that it can be ready to meet the demand when it arrives. But even more importantly, by beginning now, many insights on how the technology will evolve can be found, and this may promote a smoother transition to the new technology when it comes.

It is widely agreed that the next generation PON will be based on TDM/TDMA, just as G-PON is today. The bandwidth enhancement will be achieved by operating at 10 Gb/s, rather than 2.5 Gb/s. This follows the traditional 4x speed increase of ITU transmission systems, and seems to be a very practical choice. The name of the new system is “XG-PON,” where “XG” stands for 10 Gb/s.

The anticipated structure of the new G.xgpon is as follows. G.xgpon will contain all the definitions, abbreviations, and conventions that are common to the entire series. G.xgpon.1 will provide the general requirements. The requirements will include the support of multiple existing and emerging services across multiple market segments, such as consumer, business, and mobile backhaul, with utilizing emulation and/or simulation of legacy services effectively. G.xgpon.2 will define the physical media dependent layer (the optics) of the system. G.xgpon.3 will define the transmission convergence layer (the protocol). G.xgpon.4 will describe the ONU management layer. The anticipated schedule is for the first three recommendations to be consented by the end of 2009, and the remaining two to be completed by mid 2010. It remains a challenge to meet this very aggressive schedule.

4.2 General OMCI

One interesting possibility is a convergence of several opti-

cal access systems on a common management system: the OMCI. In the B-PON and G-PON systems, the OMCI was described in the system series, and there were minor variations in how each version of the OMCI operated. However, at the present time, it seems likely that point to point, G-PON, XG-PON, and perhaps even EPON systems may use OMCI for their ONU management solution.

The current plan is to establish an OMCI recommendation that provides a menu of all the managed entities, operations, and other common functions. This recommendation would carry the vast bulk of the current G-PON OMCI. Then, each technology would have a relatively lightweight OMCI recommendation that would refer to the common OMCI for those elements it needs, plus any technology specific adaptations.

5. Conclusion

This paper reviewed standardization trends of optical access networks with a focus on the work in ITU-T. First, the recent progress of G-PON was described. The topics included refinement of the wavelength allocation to prepare to the next generation PON, as well as enhancement for optical line supervision to allow an advanced operation. Next, the recent progress of the point-to-point optical access systems was introduced. In addition to an overview of Gigabit point-to-point optical access system under standardization, the silent-start function to be added to 100M and 1G point-to-point recommendations was described. Lastly, the future plan of 10Gigabit-capable PON and general OMCI was explained.

References

- [1] J.O. Farmer and K. Bourg, “Practical deployment of passive optical networks,” *IEEE Commun. Mag.*, vol.46, no.7, pp.136–145, July 2008.
- [2] Y. Maeda, K. Okada, and D. Faulkner, “FSAN OAN-WG and future issues for broadband optical access networks,” *IEEE Commun. Mag.*, vol.39, no.12, pp.126–132, Dec. 2001.
- [3] ITU-T G.984.1 Gigabit-capable passive optical networks (GPON): General characteristics, 2008.
- [4] ITU-T G.984.2 Gigabit-capable Passive Optical Networks (GPON): Physical Media Dependent (PMD) layer specification, 2003.
- [5] ITU-T G.984.3 Gigabit-capable Passive Optical Networks (G PON): Transmission convergence layer specification, 2008.
- [6] ITU-T G.984.4 Gigabit-capable Passive Optical Networks (G PON): ONT management and control interface specification, 2008.
- [7] ITU-T G.984.5 Gigabit-capable Passive Optical Networks (G PON): Enhancement band, 2007.
- [8] ITU-T G.984.6 Gigabit-capable passive optical networks (GPON): Reach extension, 2008.
- [9] ITU-T G.985 100 Mbit/s point-to-point Ethernet based optical access system, 2003.
- [10] <http://www.itu.int/ITU-T/publications/recs.html>
- [11] Y. Enomoto, H. Izumita, and M. Nakamura, “Over 31.5 dB dynamic range optical fiber line testing system with optical fiber fault isolation function for 32-branched PON,” *Optical Fiber Communication Conference (OFC) 2003*, ThAA3, 2003.
- [12] R.P. Davey, et al., “Long-reach passive optical networks,” *J. Lightwave Technol.*, vol.27, no.3, pp.273 – 291, 2009.
- [13] J. Kani, R. Kubo, M. Okada, Y. Fujimoto, and K. Kumozaki, “Adaptive optical network unit for point-to-point and point-to-multipoint

Gigabit Ethernet-based optical access networks," *IEICE Electron. Express*, vol.5, no.10, pp.361–365, 2008.



Frank Effenberger was a staff scientist at *Bellcore* where he analyzed all types of access network technologies. He witnessed the early development of the FSAN initiative and the development of the APON standard. In 2000, he moved to *Quantum Bridge*, where he managed system engineering in their PON division. This work supported the development and standardization of advanced optical access systems based on B-PON and G-PON technologies. In 2006, he became Director of FTTx in the

advanced technology department of *Huawei Technologies USA*. He remains heavily involved in the standards work, and has been a leading contributor and editor of the major PON standards in the ITU. He is working on forward-looking fiber access technologies, including the 802.3av 10G EPON and ITU NGA topics. In 2008, he became the chairman of ITU-T Q2/15.



Jun-ichi Kani received the B.E., M.E., and Ph.D. degrees from Waseda University, Tokyo, Japan, in 1994, 1996, and 2005, respectively, all in applied physics. In 1996, he joined the NTT Optical Network Systems Laboratories, where he was engaged in research on optical multiplexing and transmission technologies. Since 2003, he has been with the NTT Access Network Service Systems Laboratories, where he is engaged in research and development of optical communication systems for metro and access applica-

tions. He received the Best Paper Award from the Third Optoelectronics and Communications Conference (OECC) in 1998, the Asia-Pacific Conference on Communications (APCC)/IEEE ComSoc Asia-Pacific Board Joint Award in 2001, the Young Scientist Award from the IEEE LEOS Japan Chapter in 2003 and two other conference awards. He has been participating in ITU-T and the FSAN initiative since 2003, and is serving as the associate chairman of ITU-T Q2/15. He is a member of IEEE.